

Operator's Manual for LXD series ovens

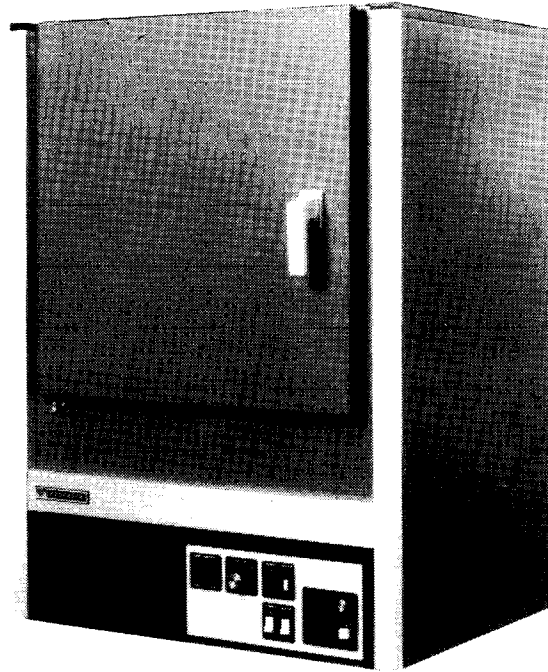

Despatch LXD series ovens are bench ovens with a maximum operating temperature of 316°C (600°F) and with forced convected airflow.

MODEL	VOLTS	PHASE	HZ	HEATER WATTS	TOTAL AMPS
LXD 1-42	240	1	60	3,000	14.6



DESPATCH
INDUSTRIES, INC.

Box 1320, Minneapolis, Minnesota 55440 (612) 331-1873 Telex 29-0704
3965 Nashua Dr., Mississauga, Ontario L4V 1P3 (416) 677-4951 Telex 06-983-598

INTRODUCTION

The Despatch LXD 1-42 is a precise high quality, high volume oven featuring a horizontal airflow system for rapid, uniform distribution of heat throughout the chamber.

To obtain optimal results from your Despatch oven, thoroughly familiarize yourself with this manual and the various procedures outlined.

WARNING: Failure to heed these restrictions can result in property damage, serious bodily injury or death.

DO NOT use oven in wet, corrosive, or explosive atmosphere.

DO NOT attempt any service on this equipment without disconnecting the main power switch.

DO NOT exceed maximum operating temperature of 316°C (600°F).

DO NOT use any flammable solvent or other flammable materials or enclosed containers in the oven.

Unpacking, Inspection and Packing List

Remove all packing materials and inspect the oven for damage. If damaged, and damage is due to shipment, contact the shipper immediately. If oven parts are damaged, or if parts are missing, contact Despatch Customer Service at 800/328-5476. (In MN 800-462-5396)

You should have in this box:

- One oven
- Two shelves
- One package containing four rubber feet
- One operators manual
- Warranty card

Any optional accessories ordered will be shipped separately.

Installation

Remove the adhesive backing sheet from the rubber feet and attach the rubber feet to the bottom corners of the oven.

Place the oven on a bench top or an optional cabinet base. The oven must have a minimum of 2" clearance in the rear to provide proper ventilation but may be placed next to another cabinet or oven (the doors will still open).

Make sure oven is level and plumb, this will assure proper heat distribution and operation of all mechanical components.

Check the oven power requirements for amperage and voltage (this is listed on the cover of the manual). Connect the electric supply directly to your oven (see electrical schematic in back of manual) with all required grounding and safety equipment, in compliance with applicable codes, ordinances and accepted safe practices.

A note on line voltage: Line voltages may vary according to your geographical location. If line voltage is significantly lower than oven voltage rating, heat up times will be extended, and motor may overheat. If line voltage varies $\pm 10\%$ from the oven voltage rating, temperature control will operate erratically.

Ovens designed for 240 volts (see name plate on oven) will operate satisfactorily on a minimum of 208 volts, but with a reduction in heater power. If your power characteristics are lower, contact Despatch Industries, Inc.

A. PRE-START-UP

1. KNOW THE SYSTEM:

Read this manual carefully. Make use of its instructions and explanations. The "Know How" of safe, continuous, satisfactory, trouble free operation depends primarily on the degree of your understanding of the system and of your willingness to keep all parts in proper operating condition.

2. CHECK LINE VOLTAGE

This must correspond to nameplate requirements of motors and controls. A wrong voltage can result in serious damage.

3. FRESH AIR DAMPER

Do not be careless about restrictions in and around the fresh air and exhaust openings and stacks. Under no condition, permit them to become so filled with dirt that they appreciably reduce the air quantity.

B. START-UP

1. START FAN AND CHECK ROTATION

Rotation MUST correspond to the directional arrows provided.

2. ADJUST HI-LIMIT TO OPERATING POSITIONS

The hi-limit thermostat can be used for the protection of the equipment or the product against excessive temperatures when set properly.

Hi-limit thermostats of the non-indicating type (ones which do not show the temperature) can be properly set only after oven is in operation. Until then, such thermostats should be set at their maximum positions so all preliminary testing and adjusting can be done. Before putting oven into production, adjust this type of thermostat as follows: Set the temperature control thermostat at 14°C (25°F) above the desired operating

temperature. Operate oven until the control thermostat is regulating. Carefully adjust the hi-limit downward until it trips. Reset the temperature control thermostat at the desired operating temperature. The two instruments are now set in their correct positions.

NOTE: Never operate oven at a temperature in excess of the maximum operating temperature which is 316°C (600°F).

NOTE: All ovens are tested at the factory; however, shipping may cause damage or deviation. Therefore, before oven is put into regular service, the following items should be inspected and adjusted if necessary: thermostat calibration, doors, hinges, latches and other miscellaneous parts.

C. OPERATION

1. KEEP EQUIPMENT CLEAN

Gradual dirt accumulation retards air flow. A dirty oven can result in unsatisfactory operation such as unbalanced temperatures in the work chamber, reduced heating capacity, reduced production, overheated components, etc.

Keep the walls, floor and ceiling of the oven work chamber free of dirt and dust. Floating dust or accumulated dirt may produce unsatisfactory results.

Keep all equipment accessible. Do not permit other materials to be stored or piled against it.

2. PROTECT CONTROLS AGAINST EXCESSIVE HEAT

This is particularly true of controls, motors or other equipment containing electronic components. Temperatures in excess of 51.5°C (125°F) should be avoided.

3. ESTABLISH MAINTENANCE AND CHECK-UP SCHEDULES

Do this promptly and follow them faithfully. Careful operation and maintenance will be more than paid for in continuous, safe and economical operation.

4. MAINTAIN EQUIPMENT IN GOOD REPAIR

Make repairs immediately. Delays may be costly in added expense for labor and materials and in prolonged shut down.

5. LUBRICATION

Fan motor bearings are permanently lubricated.

All door latches, hinges, door operating mechanisms, bearing or wear surfaces should be lubricated to ensure easy operation.

6. CHECK SAFETY CONTROLS

This should be done as indicated.

Make these tests carefully and do them regularly. The safety of personnel as well as the equipment may depend upon the proper operation of any one of these controls at any time.

a. TEMPERATURE CONTROL (40 hours)

Observe heater indicator light flashes every 1 to 2 seconds when the control is operating at set point temperature.

b. HI-LIMIT (40 hours)

With the oven operating at a given temperature, gradually turn the hi-limit control knob down to the set point operating temperature. The hi-limit is in control when the heater indicator light is on for 3 or more seconds at a time rather than a fraction of a second.

7. PRACTICE SAFETY

Make it a prime policy to "know what you are doing before you do it." Make CAREFULNESS, PATIENCE and GOOD JUDGEMENT the safety watchwords for the operation of your oven.

IMPORTANT

WARNING: Failure to heed these restrictions can result in property damage, serious bodily injury or death.

THE USER(S) OF THIS EQUIPMENT MUST COMPLY WITH OPERATING PROCEDURES AND TRAINING OF OPERATING PERSONNEL AS STATED IN THE OCCUPATIONAL SAFETY AND HEALTH ACT (OSHA) of 1970, SECTION 5, AND THE NATIONAL FIRE PROTECTION ASSOCIATION (NFPA) 86A of 1973 (ARTICLE 100, SECTION 2d, 5 AND APPENDIX 1).

DO NOT use any flammable solvent or other flammable materials or enclosed containers in the oven.

DO NOT attempt any service on this equipment without first disconnecting the main power switch.

DO NOT exceed the maximum operating temperature, 316°F (600°F).

DO NOT use oven in wet, corrosive or explosive atmosphere.

Operation

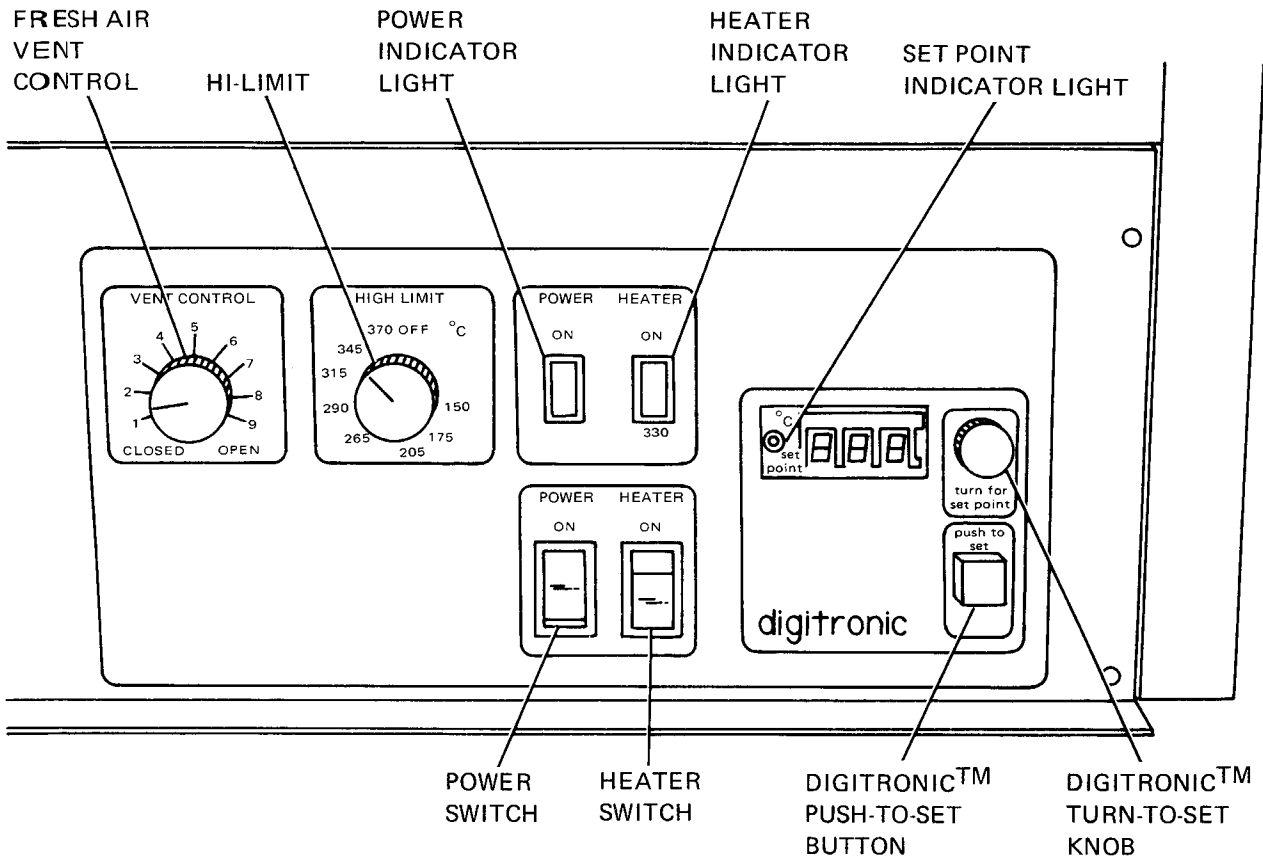

Starting the Oven

1. Push power switch to "ON" (indicator light should light). This activates the fans and control circuit.
2. Press and hold "push-to-set" button on the Digitronic™ temperature control. The display will be in the set point mode and the set point indicator light is on as long as the button is depressed.
3. Rotate "turn-to-set" knob until the desired chamber temperature is displayed. Release the "push-to-set" button. Note that the set point will be changed if knob is turned when button is not depressed.
4. Set hi-limit device by rotating hi-limit control knob to 10-15°C (18-27°F) above process temperature. Set point should be low enough to prevent damage to the workload but high enough to allow the Digitronic to control at set point. Hi-limit will assume control of heater if chamber temperature exceeds high limit set point.
5. Push heater switch to "ON". Heater indicator light should light. This activates the heating elements. When the desired temperature is reached, the Digitronic will proportion power to the heater as needed and the heater indicator light will flash on and off.
6. The readout area will alternatively display set point and actual chamber temperature. Set point is on display when the small light shows above the "set point" label.
7. Oven set point can be displayed at any time by manually depressing and holding the "push-to-set" button. This will not disengage the control function.
8. When the operating temperature is approximately 65°C (149°F) or lower, the vent(s) should be wide open to assure these low temperatures can be achieved. The fresh air vent control is located on the control panel and the exhaust vent is on top of the oven.

Loading the Oven

1. Avoid spills of anything onto the heater elements or floor of oven.
2. The two shelves are designed to be pulled out about half-way without tipping.
3. The support capacity of the shelves is 25 pounds. Do not overload the shelves.
4. Do not place the load on the oven floor plate. Placing the load on the oven floor plate may cause the load to heat unevenly. Use the shelves provided.
5. Distribute workload evenly so that airflow is not restricted.
6. Do not overfill your oven. The workload should not take up more than two-thirds of any dimension of the inside cavity.

Shutting down the oven

1. Push the heater switch to "OFF" after the heating cycle is complete.
2. Do not turn the power off until the oven temperature is below 150°C (302°F). If the oven is turned off before it is properly cooled, the fan shaft and motor bearings may become overheated, shortening the life of the motor.

How to replace parts

WARNING — Disconnect main power switch or power cord before attempting any repairs or adjustments.

Replacing control unit (Tools needed: screwdriver, either an adjustable wrench or a nut driver, pliers)

1. Disconnect power. Remove screws from the face of the control panel and slide it forward.
2. Locate the Digitronic printed circuit (PC) board.
3. Remove wires from terminal strip, noting which numbered wires connect to which terminals. Refer to wiring diagram in this manual.
4. Remove the screws holding the terminal board onto sub-panel. Replace old PC board with new PC board. Attach board to sub-panel.
5. Reattach wires to terminal strip making sure the correct ones are connected.
6. Replace control panel.

Replacing heater unit (Tools needed: crescent wrench, screwdriver)

1. Disconnect power. Remove floor plate by removing screws and lifting it out.
2. Disconnect heater leads from heater element with wrench. Note which wires go on which terminals.
3. Unscrew the screws holding the frame to the oven body. Remove the heater and discard.
4. Screw down new heater frame.
5. Attach heater leads to appropriate terminals.
6. Replace interior floor.

Replacing fan motor (Tools needed: screwdriver, 5/32" Allen wrench, and crescent wrench)

1. Disconnect power. Remove chamber floor by removing screws and lifting it out.
2. Remove the screws from heater frame then tip up and to the right.
3. Loosen set screws on fan wheel inside fan housing.
4. Remove the screws from the face of the control panel and slide it forward to uncover motor.
5. Tip oven on its back.
6. Unbolt the four bolts holding the motor to the motor mount.
7. Remove motor (NOTE: After fan wheel has run at temperature for a while, it will stick to the shaft. Some force may be required to separate the two). Suggest holding the fanwheel against the insulated wall while using a mallet and center punch to loosen the shaft from the fan.

8. Disconnect motor leads from terminal block.
9. Hold new motor in place while you remount fan wheel to motor shaft. Reattach motor to motor mount.
10. Attach motor lead wires to terminal block (see wiring diagram).
11. Replace oven control panel and bottom, then tip oven upright again.
12. Adjust fan wheel for 3/16" clearance between wheel and inlet ring.
13. Tighten set screws making sure set screws hit the flats machined into the motor shaft.
14. Bolt heater back in place.
15. Replace interior floor.

Replacing the hi-limit (Tools needed: small screwdriver)

1. Disconnect power. Remove the screws from the face of the control panel and slide it forward.
2. Locate control thermocouple and hi-limit bulb along the left side of the control chamber.
3. Loosen the nut on the brass fitting holding the hi-limit capillary in place.
4. Pull hi-limit capillary out of the fitting. NOTE: Avoid rough handling.
5. Carefully uncoil the new capillary tube, taking care not to kink it.
6. Feed the new hi-limit capillary through the nut and ferrule and place back into the fitting.
7. Retighten the fitting nut.
8. Remove the "hi-limit" label on the outside of the control panel.
9. Detach the old hi-limit body by unscrewing the screws that were underneath the label.
10. Remove the hi-limit and discard.
11. Attach the new hi-limit. Put on the new label. Reattach the knob.
12. Replace control panel of oven.

Recalibrating the hi-limit (Tools needed: small screwdriver)

The hi-limit device was calibrated at our factory; however it may need periodic checking and recalibration. If the hi-limit overrides the Digitronic when the hi-limit is set above Digitronic set point, the hi-limit needs recalibration. The hi-limit

is in control when heater indicator light is lit for 2-3 seconds at a time rather than for a fraction of a second. Recalibrate using the following procedures:

1. Turn oven on and set controller at 260°C (500°F). It should be stabilized at temperature for about one hour before adjustments are made.
2. Set hi-limit to 260°C (500°F). Pull hi-limit control knob off. Calibration screw is located in the center of the thermostat shaft.
3. 1/4 turn of the screw equals approximately 20°C (68°F).
4. If hi-limit set point is HIGHER than actual oven temperature, (Digitronic readout) turn calibration screw counter-clockwise.
5. Turn the screw until the heater shuts off.
6. If set point is LOWER than actual temperature, turn screw clockwise.
7. Turn the screw until the heater turns on.
8. If readings do not coincide within 30 minutes, repeat operation.
9. Replace knob on shaft.

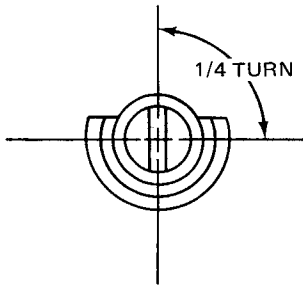

Thermocouple break protection

If the thermocouple breaks, the Digitronic will shut off power to the heater, preventing excessive temperature in the chamber. This condition will be indicated on the Digitronic digital display area by decimal points between the numerals.

The Controller thermocouple is type "J" (iron/constantan) and is replaceable using the following procedure:

1. Disconnect power and remove screws from the face of the control panel and slide it forward.
2. Locate thermocouple and hi-limit bulb along the left side of the control chamber.
3. Loosen the nut on the fitting holding the thermocouple in place.
4. Pull thermocouple out of brass fitting.
5. Feed new thermocouple through the nut and ferrule and place back into the fitting.
6. Retighten the fitting nut.
7. Remove old thermocouple from terminals marked "TC+" and "TC-" on PC board.
8. Attach new thermocouple to "TC+" and "TC-" making sure that white lead is attached to the "+" terminal and the red lead is attached to the "-".
9. Replace oven control panel.
10. If decimal points still appear between numerals, repeat procedure.

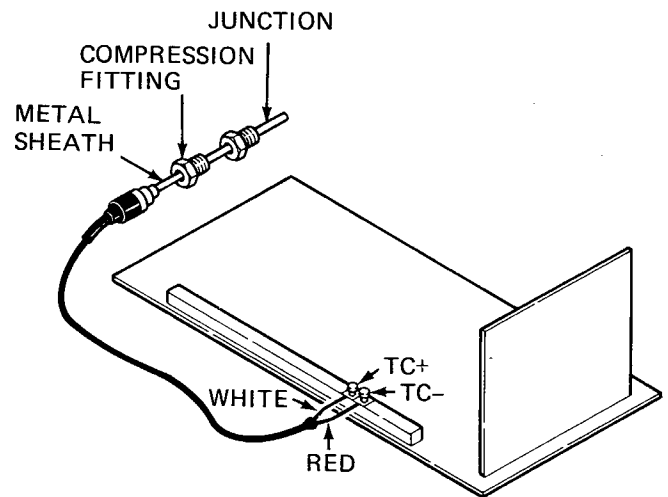

Digitronic trouble shooting

DIFFICULTY	PROBABLE CAUSE	SUGGESTED REMEDY
Erratic Sensor Readout	Broken T/C	See Thermocouple Test
	Control Malfunction	See Control Output Test
Erratic Setpoint Readout	Bad Slide Wire on 5K Potentiometer	See Potentiometer Test
	Control Malfunction	See Potentiometer Test
Inaccurate Temperatures	Control Miscalibration	See Calibration Test
Decimal Points Between the Numerals		
Sensor Readout	Thermocouple is Open or Broken	See Thermocouple Break Protection
Setpoint Readout	Overrange	Lower Setpoint Potentiometer or Input Signal Voltage

Tests

WARNING – HIGH VOLTAGE IS PRESENT ON TERMINALS. VOLTAGE CHECKS TO BE MADE ONLY BY QUALIFIED ELECTRICAL MAINTENANCE PERSONNEL: E.G., ELECTRICIAN OR TECHNICIAN. FAILURE TO HEED THIS WARNING CAN RESULT IN SERIOUS BODILY INJURY, PROPERTY DAMAGE, OR DEATH.

Thermocouple Test:

1. Place a jumper or short the terminals "TC+" and "TC-" on the control. The display should read ambient temperature and be very stable.
2. Replace the control if the unit is not stable

Control Output Test:

1. Disconnect line power from the control.
2. Remove the jumper or leads attached to terminals + and - on the control.
3. Attach a multimeter with internal impedance greater than 10,000 OHMS/volt DC across these terminals.
4. Set meter to 30 VDC range.
5. Reconnect line power to the control.
6. The meter should read approximately 10 VDC when the sensor readout is 10°C below setpoint and 0 VDC when the readout is 10°C above setpoint. The voltage should be fluctuating when both the sensor and setpoint readouts are the same.
7. Replace control if the unit does not respond as above

Potentiometer Test:

Control:

1. Most controls have a bypass resistor across terminals P1 and P2 to limit the maximum operating setpoint temperature.
2. Remove one potentiometer lead leaving the bypass resistor across P1 and P2. The setpoint display will increase to

approximately 200° to 400°, but the readout should be stable.

3. Replace control if the readout still is not stable

Setpoint Potentiometer:

1. Turn the pot all the way clockwise and then all the way counter clockwise several times. This should remove any dust or dirt from the slidewire. The setpoint should be stable.
2. Replace pot if the readout is still not stable.

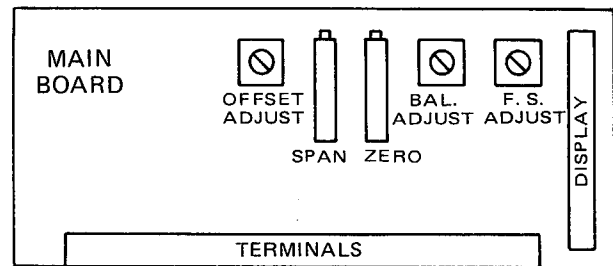

Calibration procedure

1. Disconnect line power to the control.
2. Attach an accurate potentiometer with a millivolt of Type "J" thermocouple output to the "TC+" and "TC-" terminals on the control
3. Attach a multimeter with internal impedance greater than 10,000 OHMS/volt DC across terminal + and - on the control. Remove jumper, if one was installed.
4. Set meter to 30 VDC range.
5. Turn the line voltage on.
6. Set offset, bal. adjust, and FS adjust to mid range.
7. Turn millivolt source to 0.0°C or °F. Adjust zero pot on control when necessary, if the readout is not the same.
8. Turn millivolt source to 538°C (1000°F). Adjust span pot on control when necessary if readout is not the same.

9. Turn millivolt source to 150°C (302°F).
10. Adjust the FS adjust pot if the readout is not 150°C (302°F). Turn the FS adjust clockwise to turn the readout down.
11. Turn the control setpoint pot (5K) until the meter is fluctuating at about 50% on and 50% off.
12. If the setpoint readout is not 150°C (302°F) adjust the bal. adjust until the setpoint is 150°C (302°F). Turn the bal. adjust pot clockwise to turn the setpoint up.
13. Repeat steps 11 and 12 until the setpoint and sensor temperature both read 150°C and the meter is fluctuating at 50%.
14. Disconnect all power, leads and re-install jumper if necessary.
15. Place nail polish on the zero, span, FS adjust, and bal. adjust pots.

Trouble shooting.

Any equipment operating for as many hours a day as lab ovens often do is likely to have problems now and then. Below are possible problems and suggested solutions. If you have a problem not listed and don't know what to do, contact Despatch at our toll free "Help Line" 800-328-5476 (In MN 800-462-5396).

DIFFICULTY	PROBABLE CAUSE	SUGGESTED REMEDY
Failure to heat	No power	Check power source and/or oven and wall fuses
	Burned out heating element	Replace element (see warranty statement)
	Control malfunction	See trouble shooting information on Digitronic
	Loose wire connections	Disconnect power and check connections behind control panel
Slow heat up	Improperly loaded	Reduce load or redistribute load in chamber
	Low line voltage	Supply sufficient power and proper connections. Check to see if circuit is overloaded
	Heating element burned out	Replace burned out element (see warranty statement)
	240 volt oven is connected to a 208 volt line	Reconnect heater for 208V (See wiring diagram)
Frequent heater element burn out	Fan motor failure	Replace fan motor
	Harmful fumes generated by load	Increase vent opening or discontinue process
Erratic temperatures	Overheating Oven	Do not operate over 316°C (600°F)
	Control malfunction	See trouble shooting information on Digitronic
Inaccurate temperatures	Control miscalibration	Recalibrate control (see section on control recalibration)
Excess surface temperature around door	Door seal deterioration	Replace door seal
	Clogged stack	Clean stack
	Fan motor failure	Replace fan motor
Improper airflow	Unbalanced fan wheel	Replace fan wheel

DIFFICULTY

PROBABLE CAUSE

SUGGESTED REMEDY

Excessive Vibration

Dirty fan wheel
Unbalanced fan wheel

Clean Fan
Replace fan wheel

Oven will not control at set point

Hi-limit set too low
Hi-limit is out of calibration

Set the hi-limit higher
Recalibrate the hi-limit (see directions on recalibrating the hi-limit)

Triac malfunction

Replace Triac

Control malfunction

See trouble shooting information on Digitronic

Air friction of recirculation fan

Open fresh air vent. Unit will not control below room ambient plus 45°C (81°F) with vent closed.

Heater does not shut off until the temperature reaches the hi-limit setting

Triac shorted

Replace Triac

MATERIAL LIST			
ITEM	PART NO.	QTY.	DESCRIPTION
CI	031332	1	61-06-AL DIGITRONIC CONTROL W/240 VOLT TRIAC
TR	015405	1	T6420M TRIAC
1PB	030525	1	UP-101M SWITCH
POT	030526	1	3253 POTENTIOMETER
CF	015229	1	MU 3A1 ROTRON FAN 240 V
	007471	1	F30A2 FUSE BLOCK
1FU	007532	2	FRN 5.0 FUSE TRON
2FU	007471	1	F30A2 FUSEBLOCK
1M	008335	2	A25 X 15 AMP - TRAP FUSE
1T	013315	1	BX200MPI215 - 3PK TRANSFORMER
1HL	030489	1	FNM 2 FUSE TRON
VAR	012748	1	150 - 370°C HI-LIMIT KIT V275LA1SA VARISTOR
1-2SW	012173	2	TIGK-51-66-WH-NBL SWITCH
1LT	008670	1	LT-C2-NW-A2-MF WHITE PILOT LIGHT
2LT	008662	1	LT-C2-NR-N1-MF RED PILOT LIGHT
1-2R	010434	2	PRD07AYD RELAY 25 AMP 120 V
2 RES	010485	1	7.5 OHM RESISTOR ±5%
1 HTR	007777	1	3KW WAGNER

INCLUDED
IN ITEM
C1

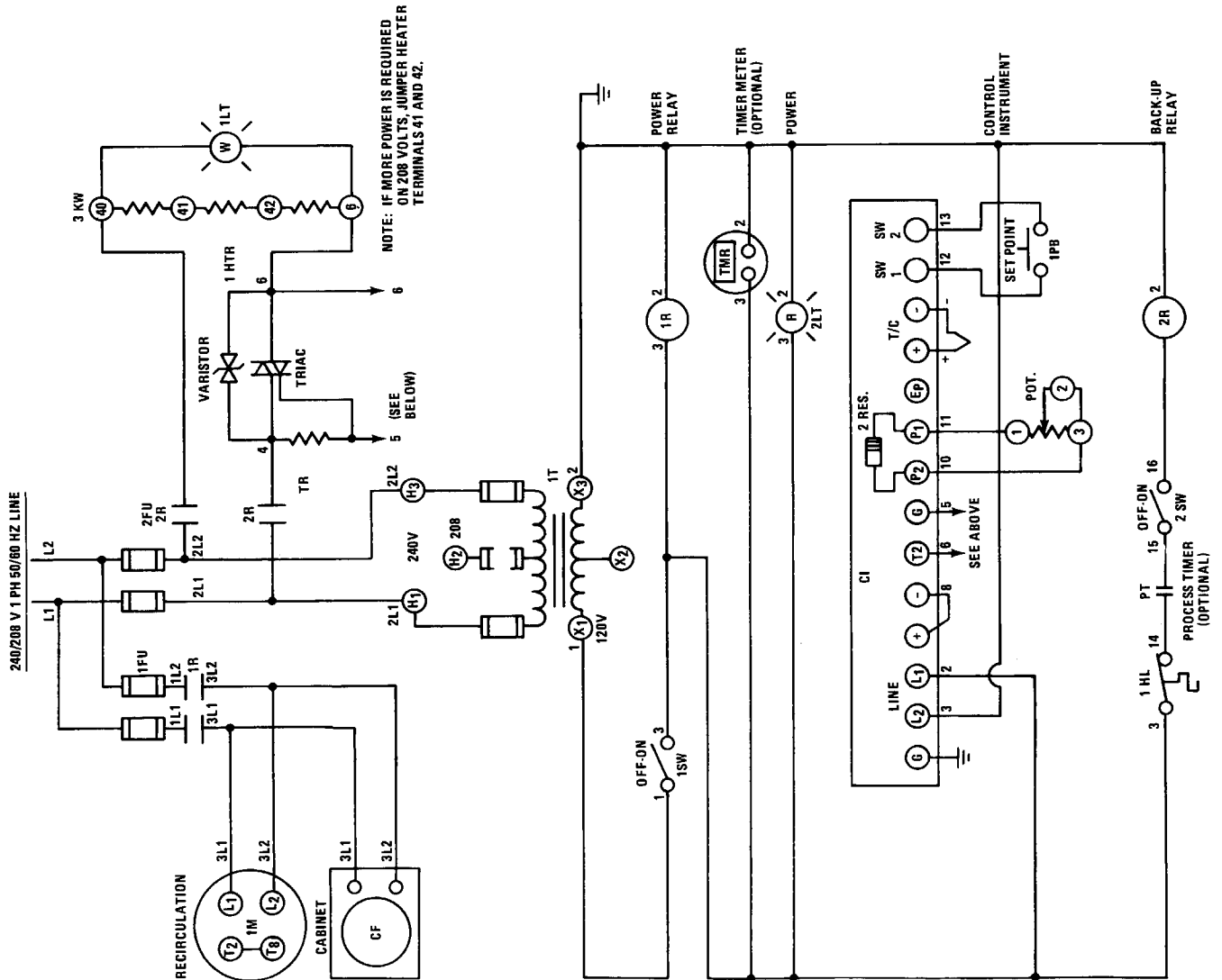
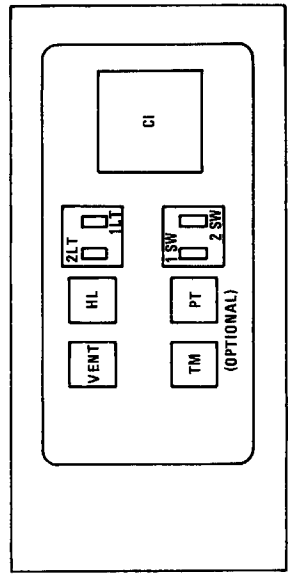

How to install LXD optional accessories:

Three optional accessories are available for LXD series ovens. They are available at any time from Despatch Industries' Customer Service Department, 800/328-5476 which is our no toll "Help Line". (MN 800-462-5396)

When you order accessories, full instructions for mounting them in the control panel will be enclosed; however, in case they are misplaced, instructions are repeated here.

Process timers. Available for 60 minutes or 6 hour cycles, these timers are electrically connected into oven control and will shut off the heater at end of cycle. (Tools needed: screwdriver, utility knife.)

1. Disconnect power, remove screws from the face of the control panel and slide it forward.
2. From back of panel, locate pre-punched holes. Process timer can be mounted in either of the two far left sets of holes. From the front of panel, use utility knife to cut holes in the silver overlay.
3. Put shaft and mounting screws through holes and screw timer into place.
4. Locate connector marked "Process Timers" on the back of the digitronic bracket. Remove jumper. Replace it with connector supplied with the timer.

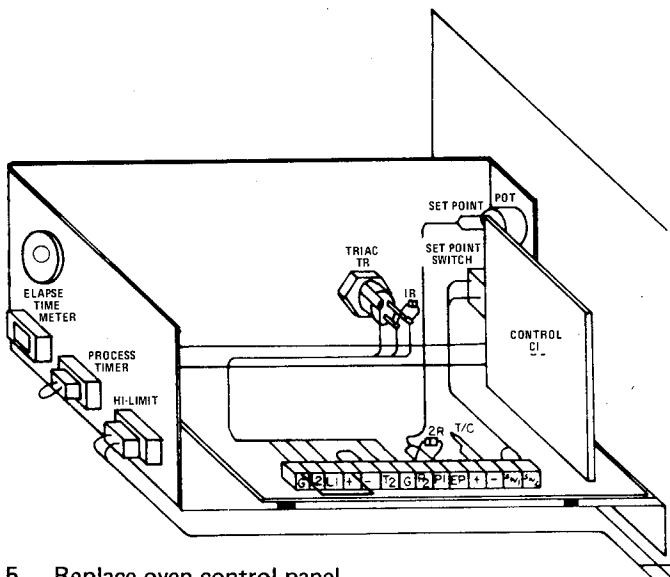

5. Replace oven control panel.
6. Peel top part of backing off black "Process Timer" sticker and apply it to front of control panel, using the two locating marks and shaft holes as location guides. Peel remaining backing off and smooth sticker down.
7. Push knob onto shaft.

Signal Timer. This timer sounds an audible bell at the end of the cycle, up to 60 minutes. It is not electrically connected to oven and does not shut off heater. (Tools needed: screwdriver, utility knife.)

1. Disconnect power, remove screws from the face of the control panel and slide it forward.
2. From back of panel, locate pre-punched holes. Signal timer can be mounted in either of the two far left sets of holes. From the front of panel, use utility knife to cut holes in the silver overlay.
3. Put shaft and mounting screws through the holes and screw timer into place.
4. Replace control panel.
5. Peel top part of backing off black "Signal Timer" sticker and apply it to front of control panel, using the two locating marks and shaft holes as location guides. Peel remaining backing and smooth sticker down.
6. Push knob onto shaft.

Running Time Meter. Digital meter counts up to 99,999.9 hours of process time. Runs continuously when oven is on. Not resettable. (Tools needed: screwdriver, utility knife.)

1. Disconnect power, remove screws from the face of the oven control panel and slide it forward.
2. From back of panel, locate pre-punched holes. The running time meter can be positioned only in the lower left set of holes. Use the utility knife to cut four holes in the silver overlay.



3. Attach meter to panel with screws.
4. Locate connector marked time meter on the back of the Digitronic bracket and connect the wired connector from the meter to it.
5. Replace control panel.
6. Peel top part of backing off black "Running Time" sticker and apply it to the front of the control panel using locating marks and meter hole as location guides. Peel remaining backing off and smooth sticker down.
7. Meter will operate when oven is on.

Industrial Equipment Commercial Warranty

Despatch Industries, Inc. warrants equipment manufactured by Despatch Industries, Inc., to be free from defects in workmanship and materials under normal use and service for a period of one (1) year from the date of delivery or the period of twenty-one hundred (2100) accumulated hours of use, whichever period is shorter.

Components manufactured by others, including but not limited to expendable items, are excluded from this warranty and are warranted (if at all) only in accordance with the warranty, if any, issued by such other manufacturer.

Use or service with corrosive or abrasive chemicals or materials is not deemed normal.

If Purchaser gives written notice specifying the particular defect or defects within 14 days after discovery thereof, Despatch Industries, Inc. will correct without charge any workmanship that is demonstrated to Despatch Industries, Inc. satisfaction to have been defective at time of installation or erection and will repair or replace, at the warrantor's option, without charge, f.o.b. Despatch Industries, Inc. factory, parts covered by this warranty that upon inspection are found defective under normal use within the warranty period above stated.

All work of removal and reinstallation or installation of parts, whether or not found defective, and shipping charges for defective or replacement parts shall be at the sole expense of Purchaser.

The foregoing warranty shall not apply to equipment repaired or altered by others, unless such repairs or alterations were specifically agreed to in writing by an officer of Despatch Industries, Inc.

Despatch Industries, Inc. shall not be liable for incidental or consequential damages of any kind (whether for personal injury, lost profits or otherwise), whether arising from breach of this warranty, negligence or other tort or otherwise, which occur during the course of installation of equipment, or which result from the use or misuse by user, its employees or others of the equipment supplied hereunder, or from any malfunction or nonfunction of such equipment, and Purchaser's sole and exclusive remedy against Despatch Industries, Inc. for any breach of the foregoing warranty or otherwise shall be for the repair or replacement of the equipment or parts thereof affected.

The foregoing warranty shall be valid and binding upon Despatch Industries, Inc. if and only if user loads, operates and maintains the equipment supplied hereunder in accordance with the instruction manual to be provided upon delivery of the equipment.

Despatch Industries, Inc. does not guarantee the process of manufacture by user or the quality of product to be produced by the equipment supplied hereunder and Despatch Industries, Inc. shall not be liable for lost profits.

THE FOREGOING WARRANTY IS EXCLUSIVE AND IN LIEU OF ALL OTHER EXPRESS AND IMPLIED WARRANTIES AND REPRESENTATIONS WHATSOEVER, INCLUDING BUT NOT LIMITED TO THOSE OF MERCHANTABILITY OR OF FITNESS FOR A PARTICULAR PURPOSE



DESPATCH
INDUSTRIES, INC.

Box 1320, Minneapolis, Minnesota 55440 (612) 331-1873 Telex 29-0704

3965 Nashua Dr., Mississauga, Ontario L4V 1P3 (416) 677-4951 Telex 06-983-598